

# 建设项目

项目名称：一汽模

部件工厂二

建设单位（盖章）：

编制日期：\_\_\_\_\_

中华人

打印

项

建

建

环

境

单

位

统

法

定

主

要

直

接

单

位

统

三

1.

2.

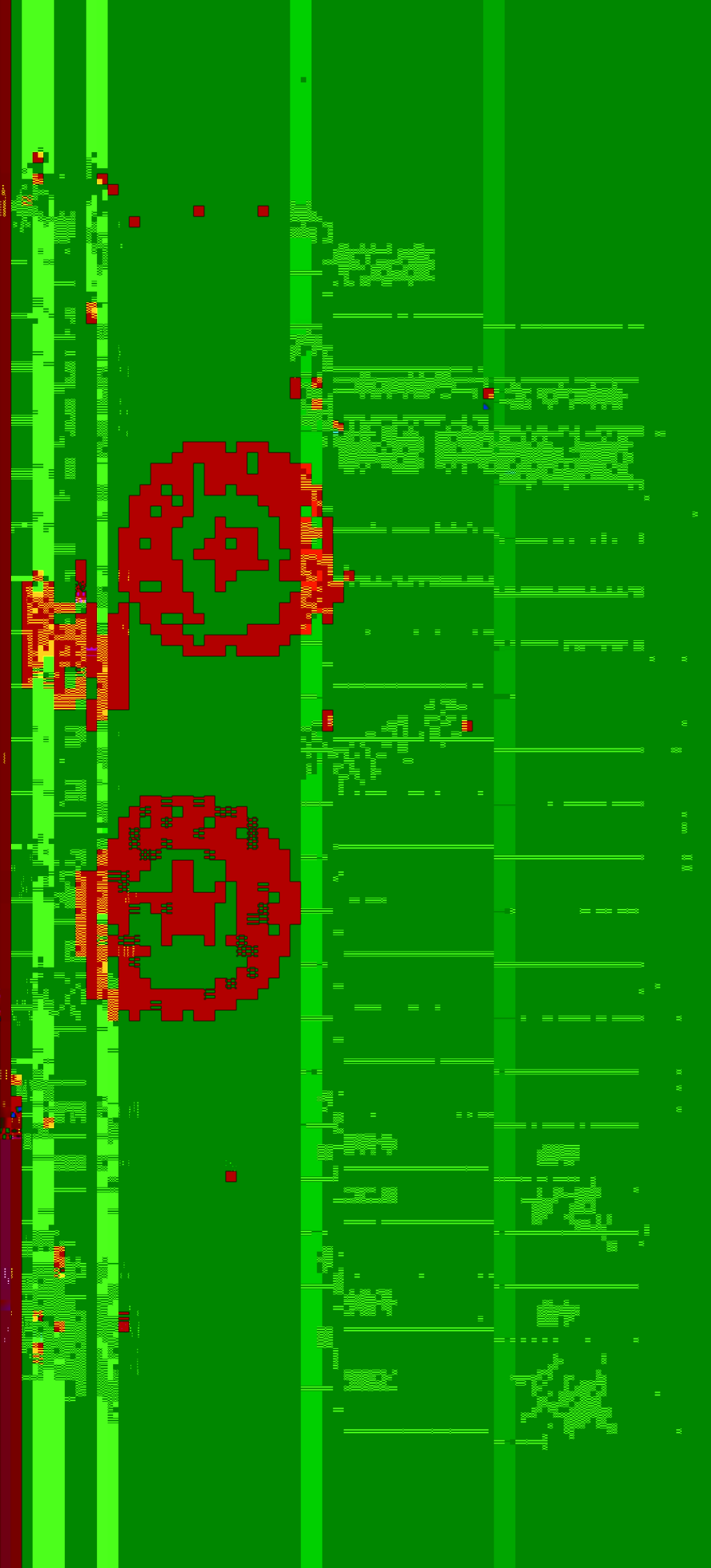

信符九不提车境及刘20要次单编“黑

建设

位一

项

款规

家条

本单

家部

告书

；该

（环

1000

包

）等

编

理

办

。

基

理

可

火

一

未

规

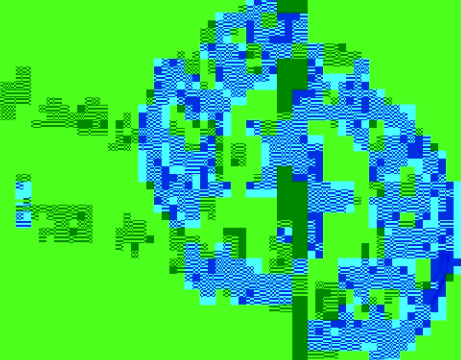
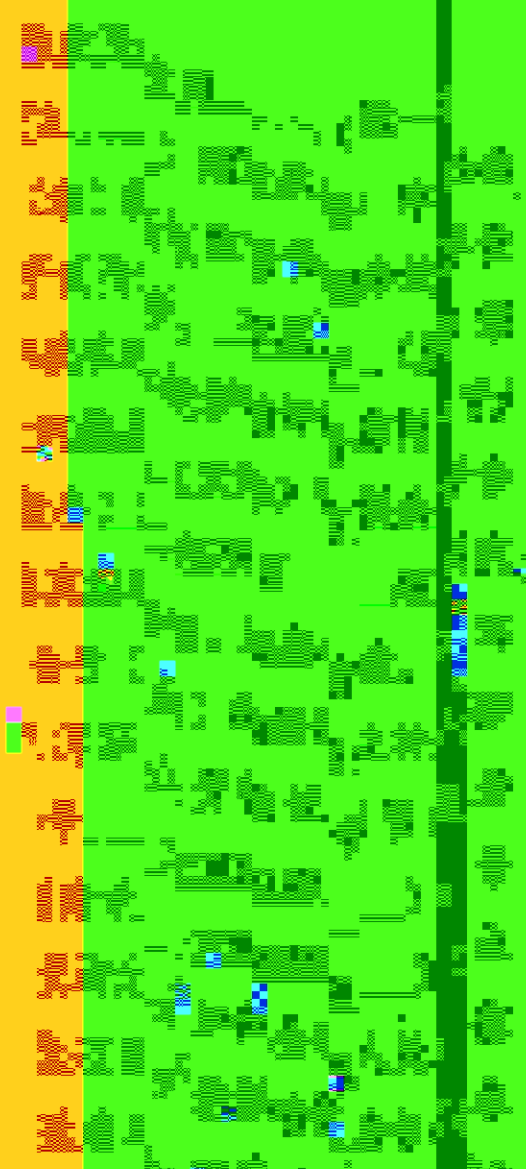
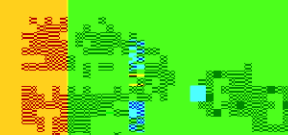

# 环境影响评价工

Environmental Impact Assessment



能力。

性 别： 男

出生年月： 1985年11月

批准日期： 2018年05月20日



中华人民共和国  
人力资源和社会保障部

中华人民共和国  
生态环境部





现状

温  
1、老  
2、法  
3、sb  
章  
4、



1

2

3

“ ”

4

5

6

7





”

”

”

”



"

"

-

"

"

"

"





	" "		





È











			

||

||

||

0% 0000

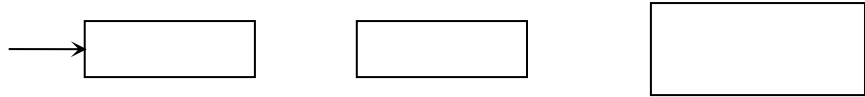
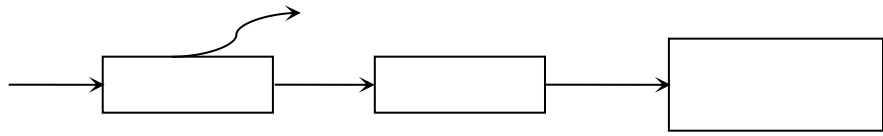



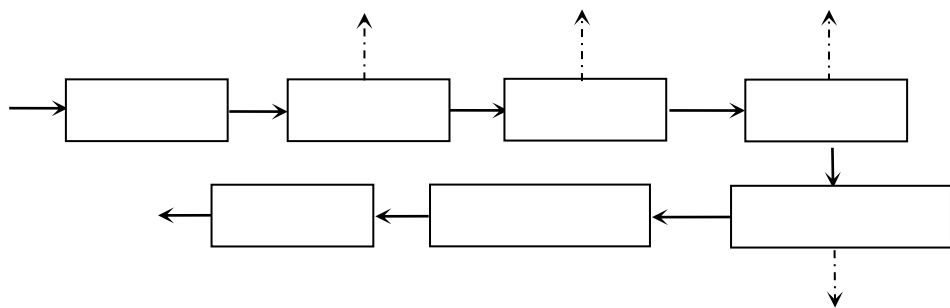

15

27



400

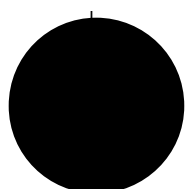





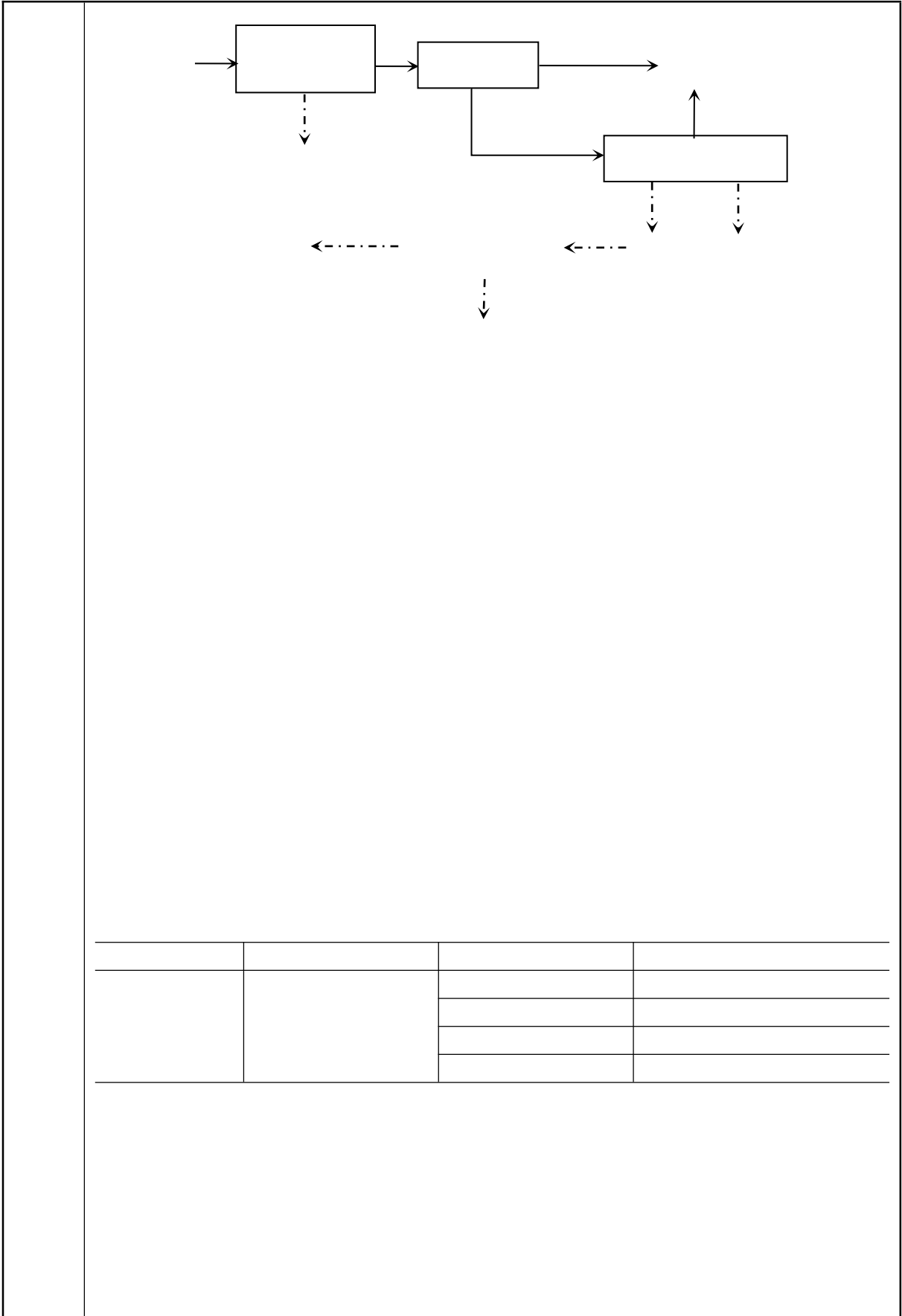



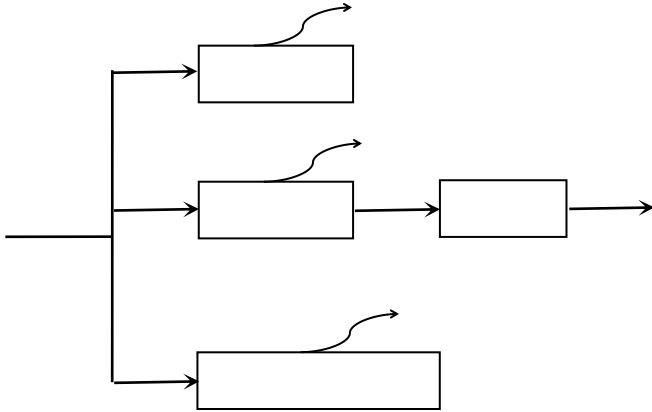

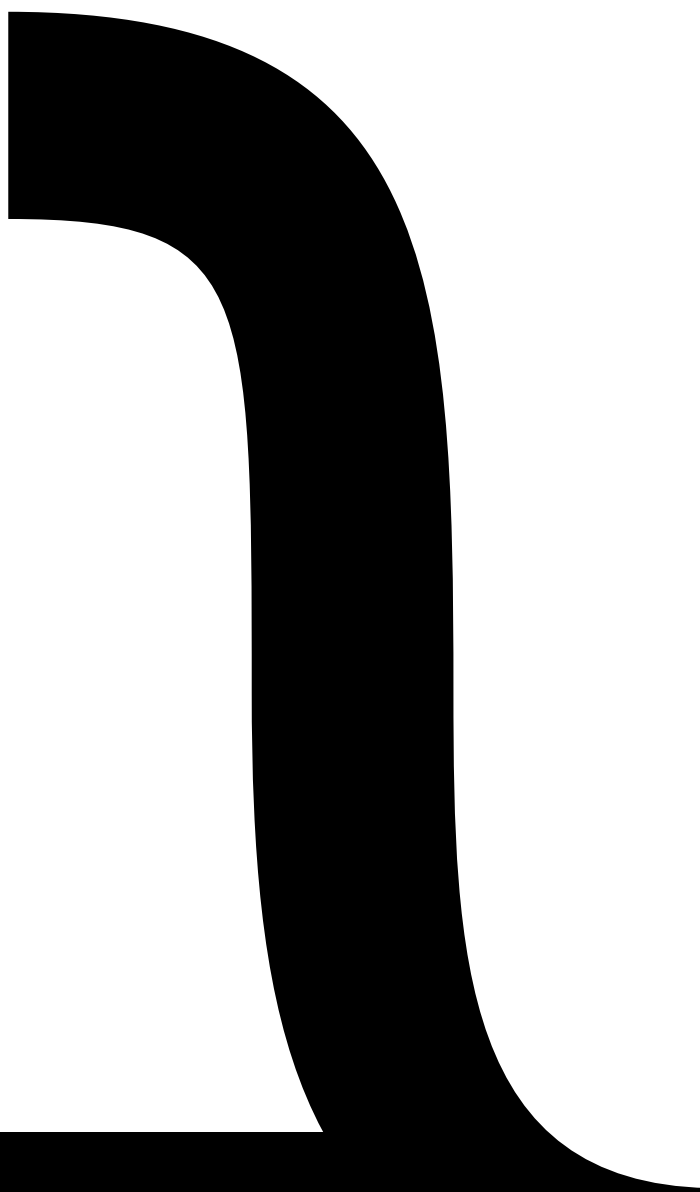
—



8.p/2

**PROBLEMS**





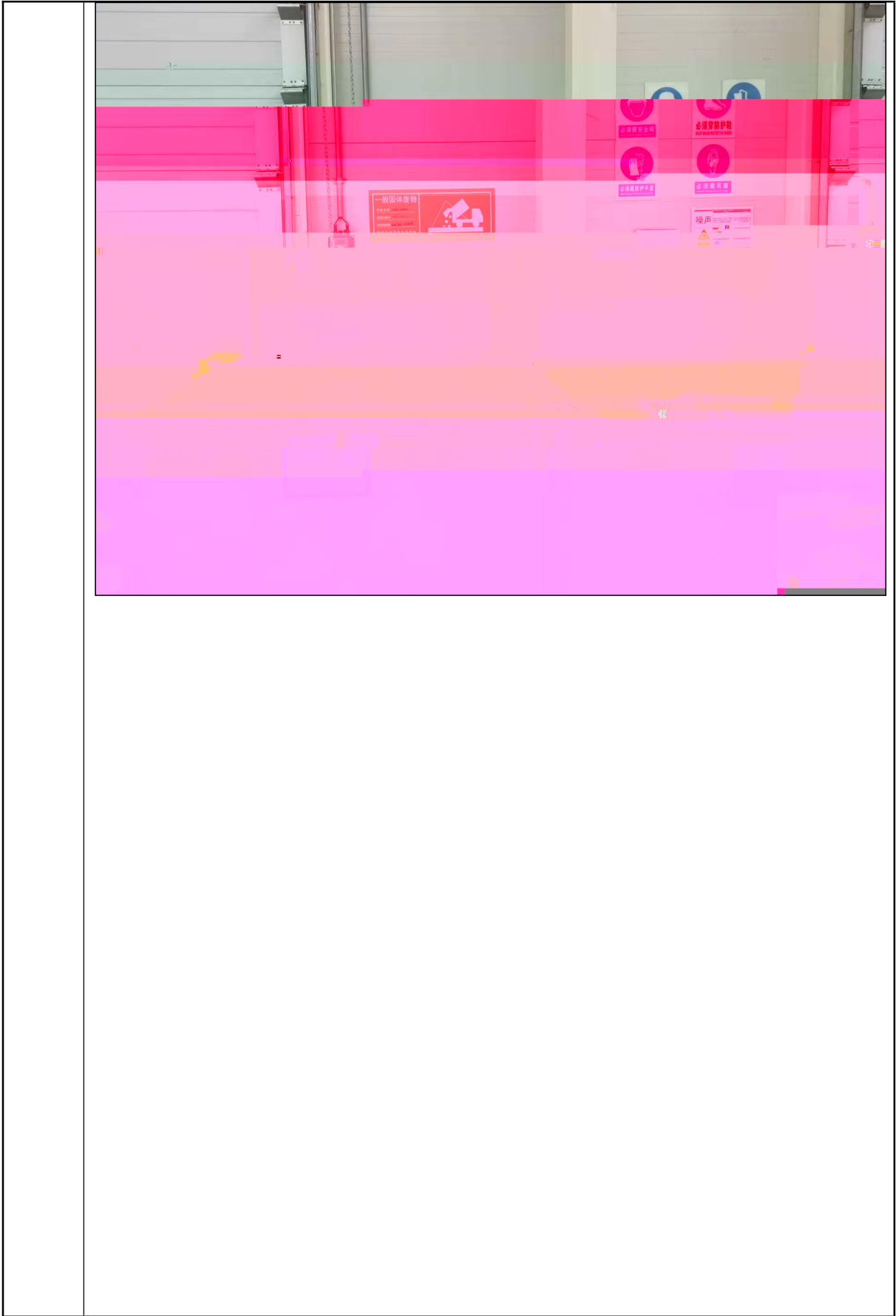

—



Q @ }Qa

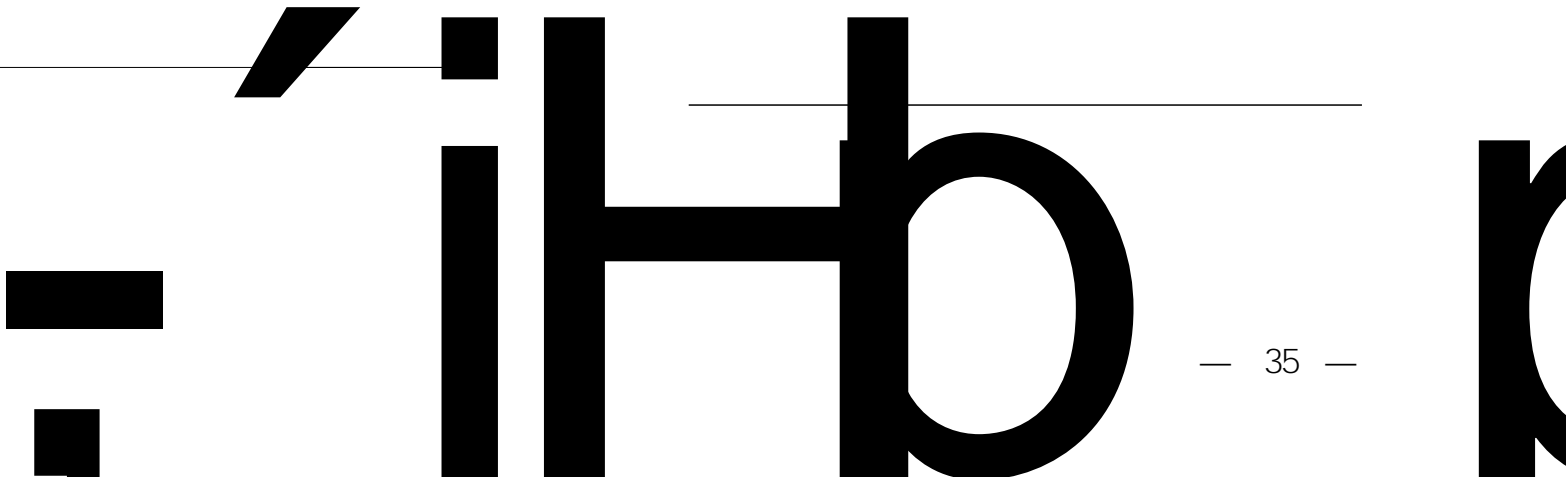

**KLUDGE**

n

**B**













$$= \sum_{=}$$

$$= -$$

= +









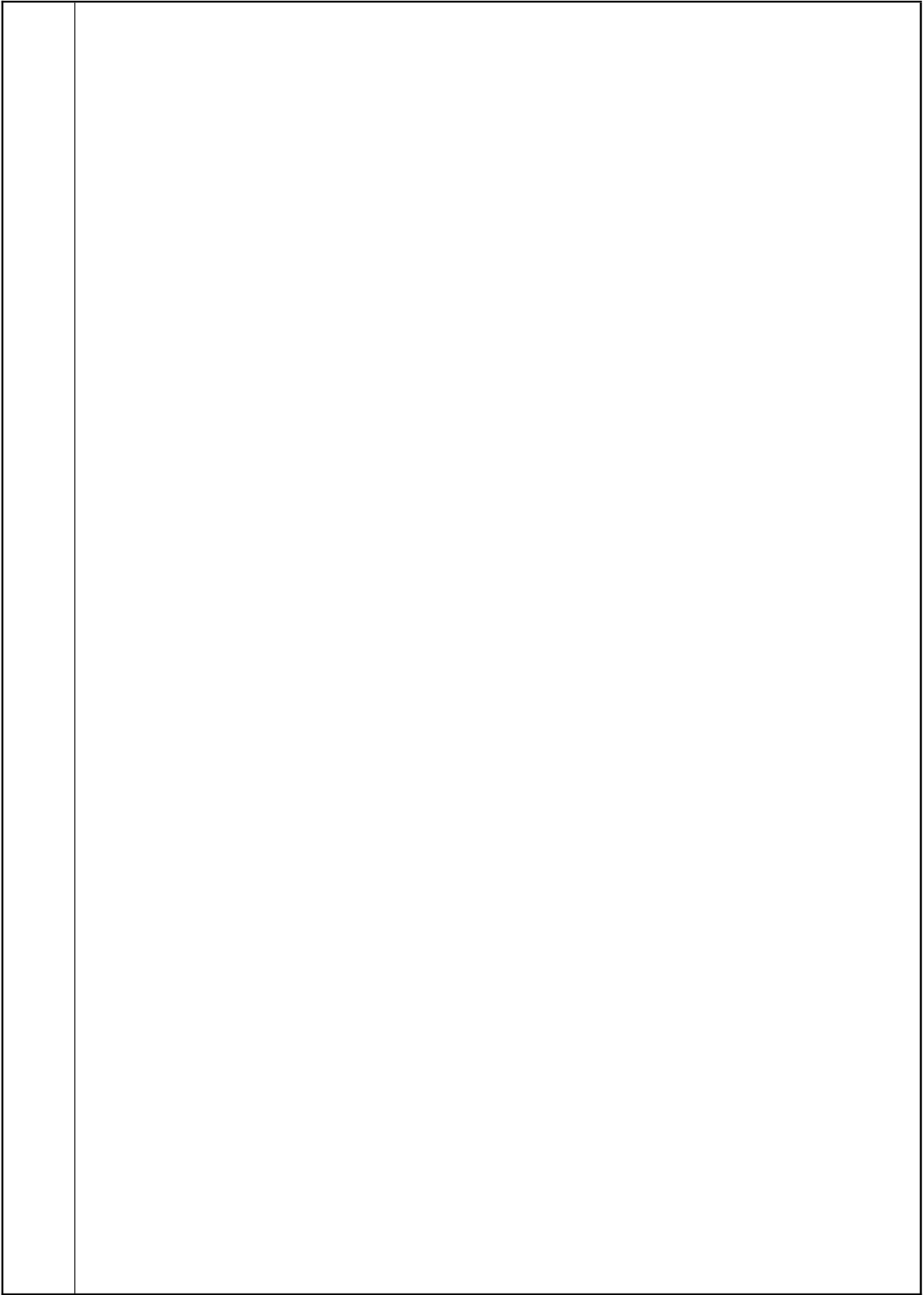

--	--

"

"

i





m'

—

(  
)/

/

/

/

/

+

È

ì

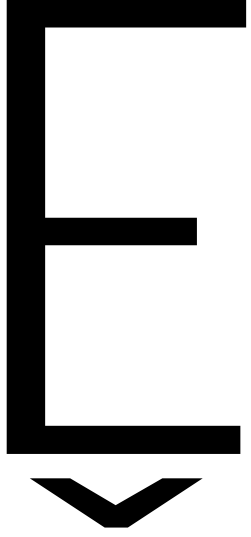

m' Ê m' m' Ê m'  
m' m' ž d

--	--



B-

¼ «A.050) d i

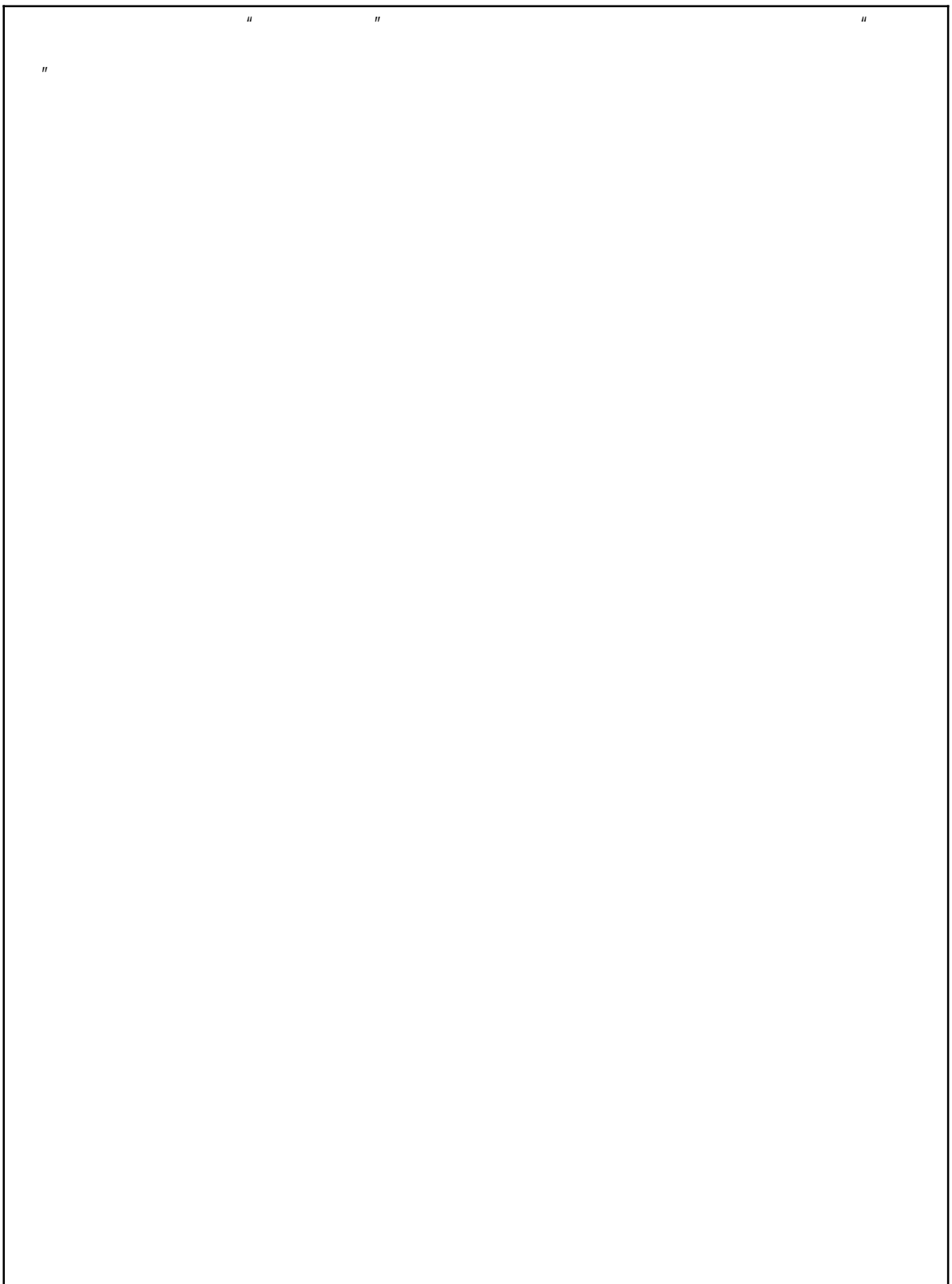



= + + - = -

# 天津市地图

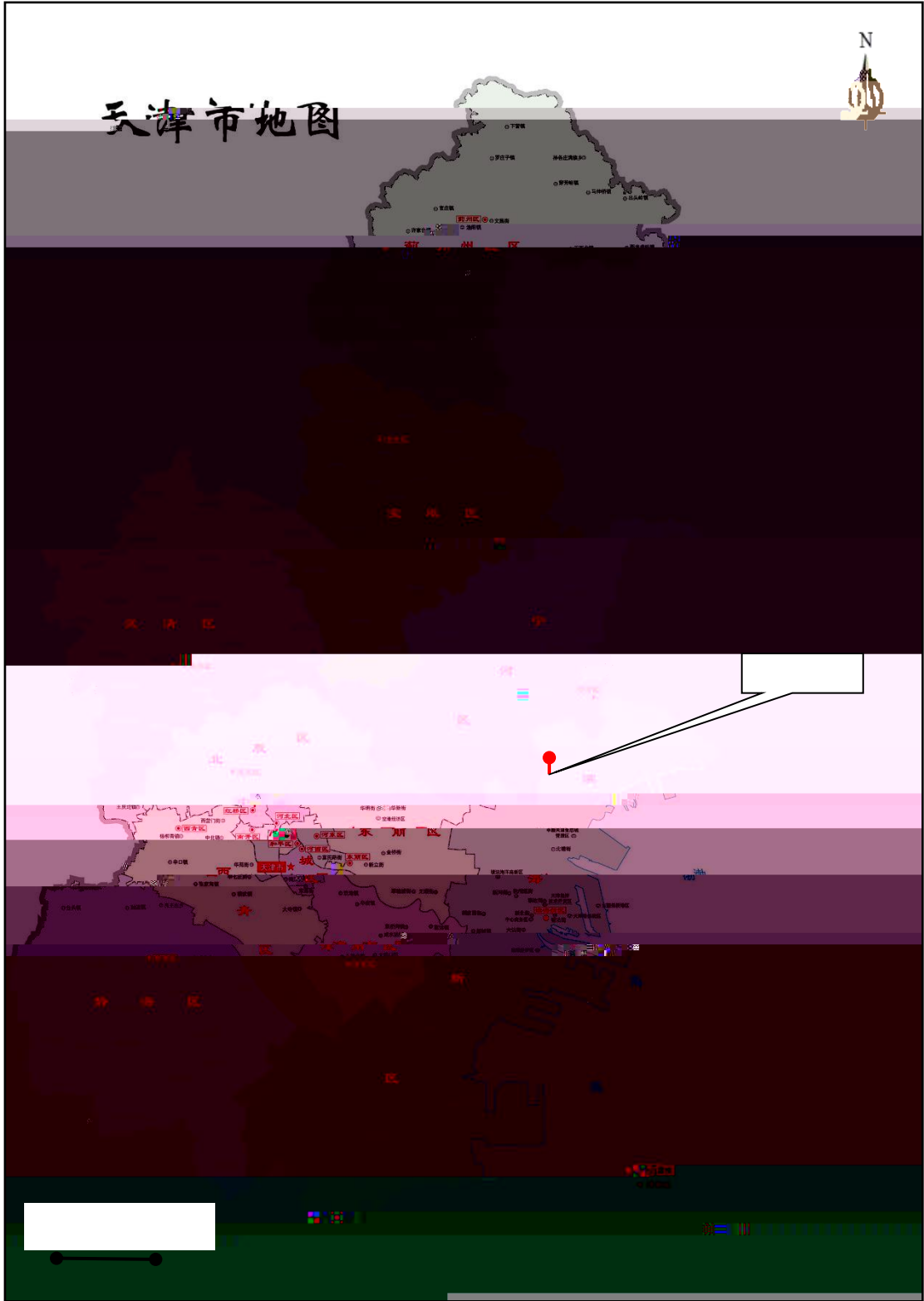

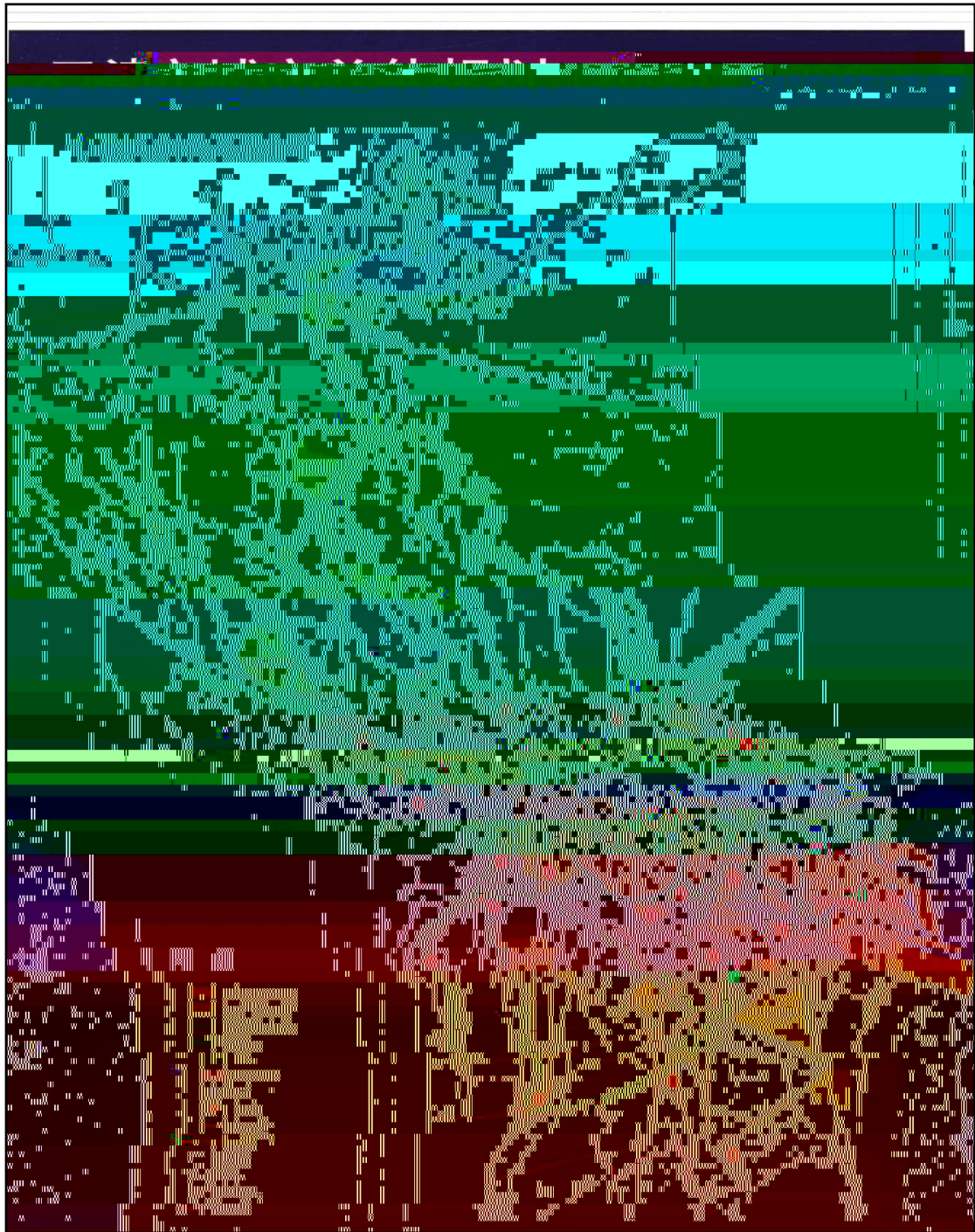



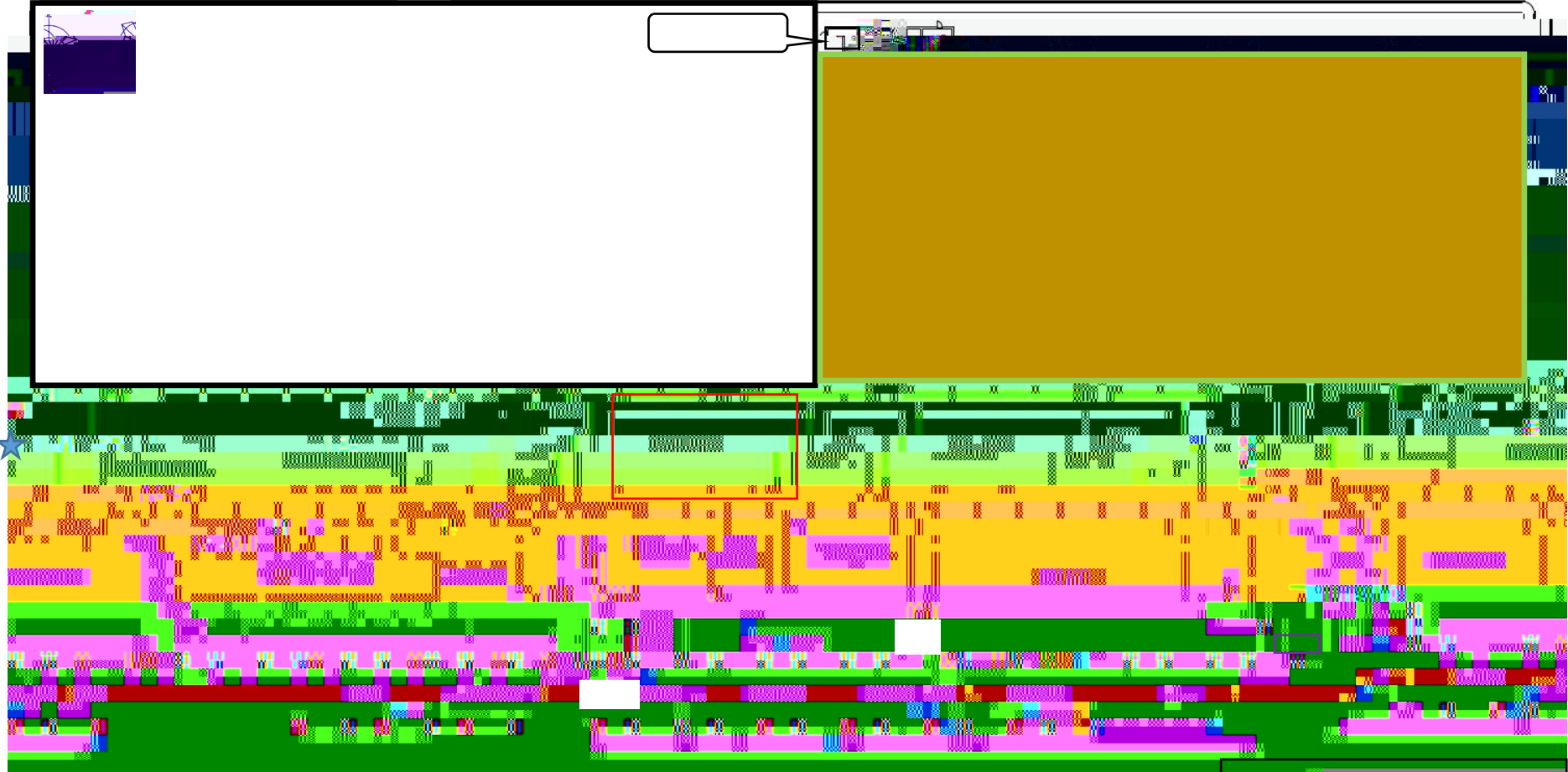

A legend box containing three symbols: a blue star, a red rectangle, and a blue double-headed arrow, corresponding to the symbols used in the main image.

# 天津市生态红线分布图

